

Dell™ 1209S Projector

**User's Guide**

# Notes, Notices, and Cautions



**NOTE:** A NOTE indicates important information that helps you make better use of your projector.



**NOTICE:** A NOTICE indicates either potential damage to hardware or loss of data and tells you how to avoid the problem.



**CAUTION:** A CAUTION indicates a potential for property damage, personal injury, or death.

---

**Information in this document is subject to change without notice.**

**© 2008 Dell Inc. All rights reserved.**

Reproduction in any manner whatsoever without the written permission of Dell Inc. is strictly forbidden.

Trademarks used in this text: *Dell*, the *DELL* logo, *Dimension*, *OptiPlex*, *Dell Precision*, *Latitude*, *Inspiron*, *DellNet*, *PowerApp*, *PowerEdge*, *PowerConnect*, and *PowerVault* are trademarks of Dell Inc.; *DLP* and *DLP*<sup>®</sup> logo are trademarks of TEXAS INSTRUMENTS INCORPORATED ; *Microsoft* and *Windows* are registered trademarks of Microsoft Corporation.

Other trademarks and trade names may be used in this document to refer to either the entities claiming the marks and names or their products. Dell Inc. disclaims any proprietary interest in trademarks and trade names other than its own.

**Model 1209S**

**May 2008 Rev. A01**

# Contents

1	Your Dell Projector . . . . .	5
	About Your Projector . . . . .	6
2	Connecting Your Projector . . . . .	7
	<b>Connecting a Computer</b> . . . . .	<b>8</b>
	Connecting a Computer using a VGA Cable . . . . .	8
	Connecting a Computer using a DVI-D Cable . . . . .	9
	Connecting a Computer using an RS232 cable . . . . .	10
	<b>Connecting a DVD Player</b> . . . . .	<b>11</b>
	Connecting a DVD Player using an S-video Cable . . . . .	11
	Connecting a DVD Player using a Composite Cable . . . . .	12
	Connecting a DVD Player using a Component Cable . . . . .	13
	Connecting a DVD Player using a HDMI Cable . . . . .	14
3	Using Your Projector . . . . .	15
	<b>Turning Your Projector On</b> . . . . .	<b>15</b>
	<b>Turning Your Projector Off</b> . . . . .	<b>15</b>
	<b>Adjusting the Projected Image</b> . . . . .	<b>16</b>
	Raising the Projector Height . . . . .	16
	Lowering the Projector Height . . . . .	16

<b>Adjusting the Projector Zoom and Focus</b> . . . . .	<b>17</b>
<b>Adjusting Projection Image Size</b> . . . . .	<b>18</b>
<b>Using the Control Panel</b> . . . . .	<b>19</b>
<b>Using the Remote Control</b> . . . . .	<b>21</b>
<b>Using the On-Screen Display</b> . . . . .	<b>22</b>
Main Menu . . . . .	23
INPUT SELECT . . . . .	23
AUTO-ADJUST . . . . .	24
SET UP . . . . .	24
PICTURE (in PC Mode) . . . . .	25
PICTURE (in Video Mode) . . . . .	26
DISPLAY (in PC Mode) . . . . .	27
DISPLAY (in Video Mode) . . . . .	28
LAMP . . . . .	29
LANGUAGE . . . . .	30
OTHERS . . . . .	31
<b>4 Troubleshooting Your Projector</b> . . . . .	<b>34</b>
<b>Changing the Lamp</b> . . . . .	<b>38</b>
<b>5 Specifications</b> . . . . .	<b>40</b>
<b>6 Contacting Dell™</b> . . . . .	<b>44</b>
<b>7 Appendix: Glossary</b> . . . . .	<b>45</b>

# Your Dell Projector

Your projector comes with all the items shown below. Ensure that you have all the items, and contact Dell™ if anything is missing.

---

## Package Contents

---

Power cable

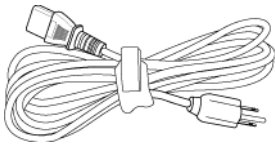

1.8m VGA cable (VGA to VGA)

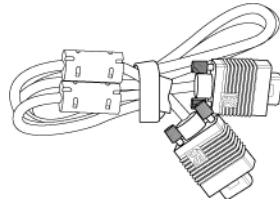

CR2032 Battery



Remote control



CD Owner's manual &  
Documentation

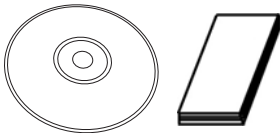

## About Your Projector

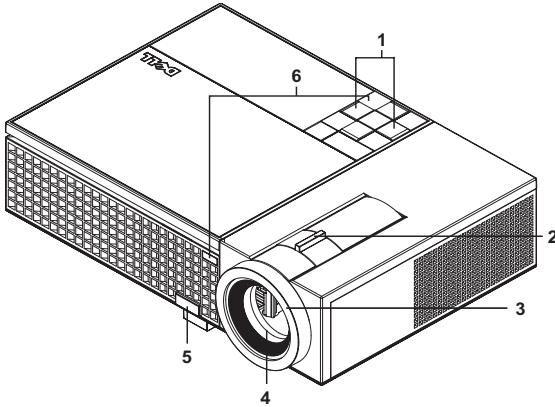

1	Control panel
2	Zoom tab
3	Focus ring
4	Lens
5	Elevator button
6	IR receivers



### **CAUTION: Safety Instructions**

- 1 Do not use the projector near appliances that generate a lot of heat.
- 2 Do not use the projector in areas where there is an excessive amount of dust. The dust may cause the system to fail and projector will automatically shutdown.
- 3 Ensure that the projector is mounted in a well-ventilated area.
- 4 Do not block the ventilation slots and openings on the projector.
- 5 Ensure the projector operates between ambient temperatures (5°C to 35°C).



**NOTE:** For more information, see the *Product Information Guide* that ships with your projector.

# 2

## Connecting Your Projector

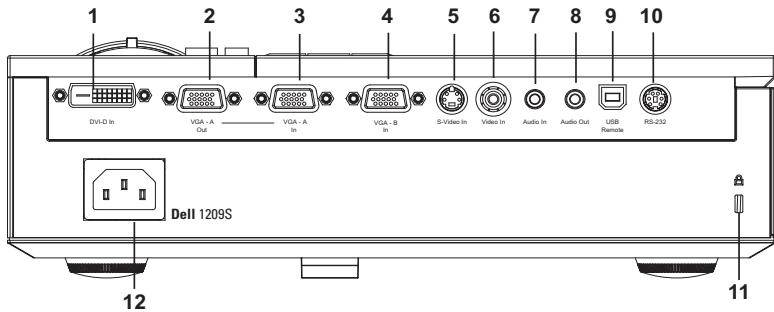

1	DVI-D input connector
2	VGA-A output (monitor loop-through)
3	VGA-A input (D-sub) connector
4	VGA-B input (D-sub) connector
5	S-video connector
6	Composite video connector
7	Audio input connector
8	Audio output connector
9	USB remote connector
10	RS232 connector
11	Security cable slot
12	Power cord connector



**CAUTION:** Before you begin any of the procedures in this section, follow the Safety Instructions as described on page 6.

# Connecting a Computer

## Connecting a Computer using a VGA Cable

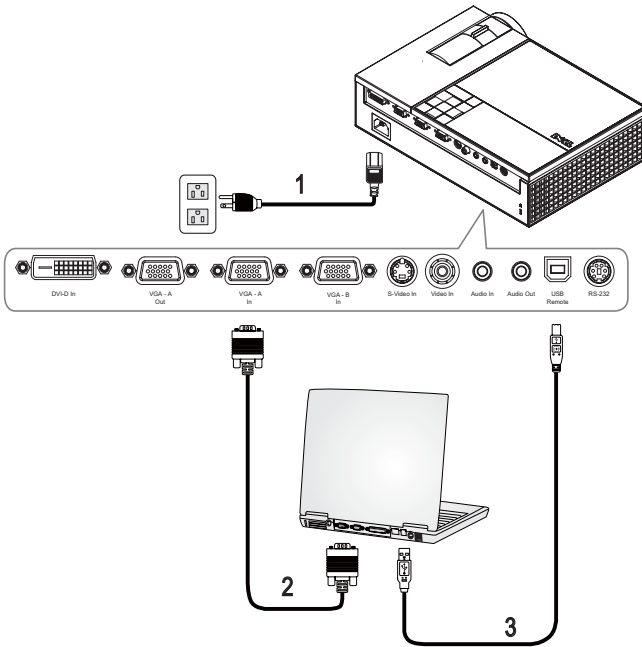

1	Power cord
2	VGA to VGA cable
3	USB to USB cable

 **NOTE:** The USB cable is not provided by Dell.

 **NOTE:** The USB cable must be connected if you want to use the Next Page and Previous Page features on the remote control.



## Connecting a Computer using a DVI-D Cable

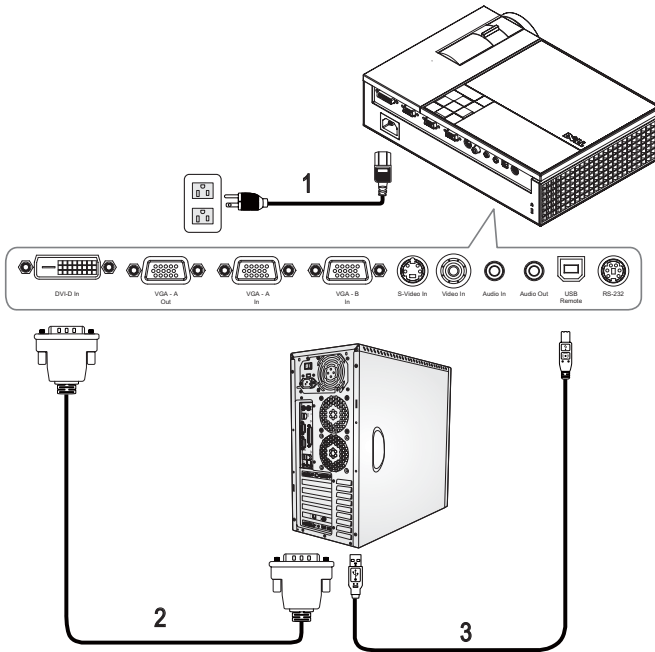

1	Power cord
2	DVI-D cable
3	USB to USB cable



**NOTE:** The USB cable and DVI-D cable are not provided by Dell.

## Connecting a Computer using an RS232 cable

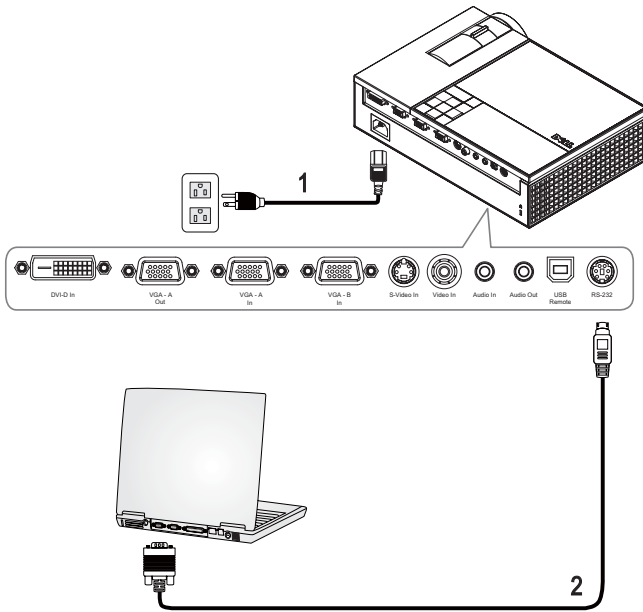

1	Power cord
2	RS232 cable



**NOTE:** The RS232 cable is not provided by Dell. Consult a professional installer for the cable and RS232 remote control software.

# Connecting a DVD Player

## Connecting a DVD Player using an S-video Cable

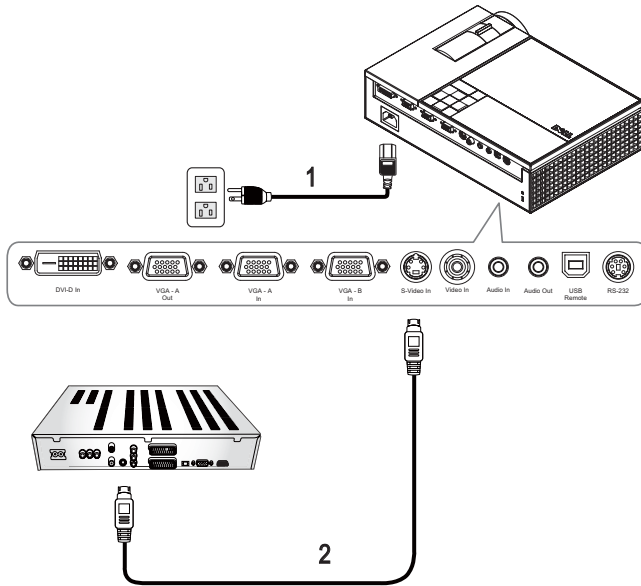

1	Power cord
2	S-video cable

**NOTE:** The S-video cable is not provided by Dell. You can buy the S-Video Extension (50ft/100ft) cable from the Dell website.

## Connecting a DVD Player using a Composite Cable

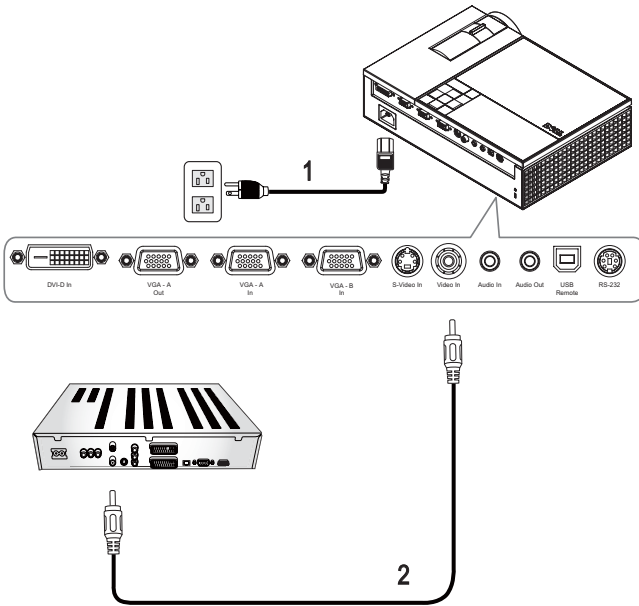

1	Power cord
2	Composite video cable



**NOTE:** The Composite cable is not provided by Dell. You can buy the Composite Video Extension (50ft/100ft) cable from the Dell website.

## Connecting a DVD Player using a Component Cable

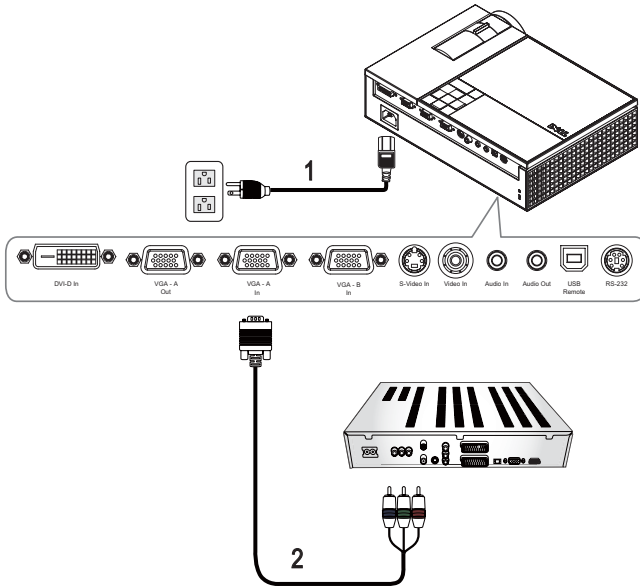

1	Power cord
2	VGA to YPbPr cable



**NOTE:** The VGA to YPbPr cable is not provided by Dell. You can buy the VGA to YPbPr Extension (50ft/100ft) cable from the Dell website.

## Connecting a DVD Player using a HDMI Cable

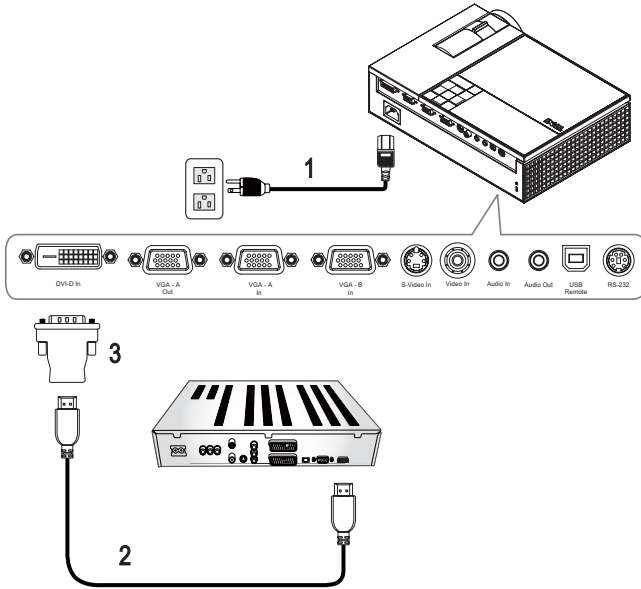

1	Power cord
2	HDMI cable
3	DVI-D adapter



**NOTE:** The HDMI cable and DVI-D adapter are not provided by Dell.

# Using Your Projector

## Turning Your Projector On

 **NOTE:** Turn on the projector before you turn on the source. The **Power** button light blinks blue until pressed.

- 1 Remove the lens cap.
- 2 Connect the power cord and appropriate signal cables. For information about connecting the projector, see "Connecting Your Projector" on page 7.
- 3 Press the **Power** button (see "Using the Control Panel" on page 19 to locate the **Power** button).
- 4 Turn on your source (computer, DVD player, etc.). The projector automatically detects your source.
- 5 The Dell Logo will continue for 30 seconds while power on.

If the "**Searching for signal...**" message appears on the screen, ensure that the appropriate cables are securely connected.

If you have multiple sources connected to the projector, press the **Source** button on the remote control or control panel to select the desired source.

## Turning Your Projector Off

 **NOTICE:** Unplug the projector after properly shutting down as explained in the following procedure.

- 1 Press the **Power** button.
- 2 Press the **Power** button again. The cooling fans continue to operate for 90 seconds.
- 3 To power off the projector quickly, press the **Power** button while the projectors cooling fans are still running.

 **NOTE:** Before you turn on the projector again, wait for 60 seconds to allow the internal temperature to stabilize.

- 4 Disconnect the power cord from the electrical outlet and the projector.

**NOTE:** If you press the **Power** button while the projector is running, the "Press Power Button to Turn off Projector" message appears on the screen. To clear the message, press the **Menu** button on the control panel or ignore the message; the message disappears after 5 seconds.

## Adjusting the Projected Image

### Raising the Projector Height

- 1 Press the **Elevator** button.
- 2 Raise the projector to the desired display angle, and then release the button to lock the elevator foot into position.
- 3 Use the tilt adjustment wheel to fine-tune the display angle.

### Lowering the Projector Height

- 1 Press the **Elevator** button.
- 2 Lower the projector, and then release the button to lock the elevator foot into position.

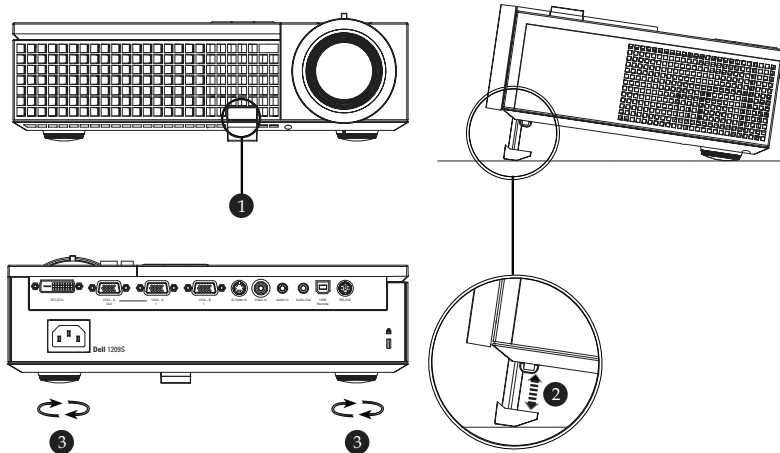

1	Elevator button
2	Elevator foot
3	Tilt adjustment wheel



# Adjusting the Projector Zoom and Focus



**CAUTION:** To avoid damaging the projector, ensure that the zoom lens and elevator foot are fully retracted before moving the projector.

- 1 Rotate the zoom tab to zoom in and out.
- 2 Rotate the focus ring until the image is clear. The projector focuses at distances ranging between 3.3 ft to 39.4 ft (1.0 m to 12 m).

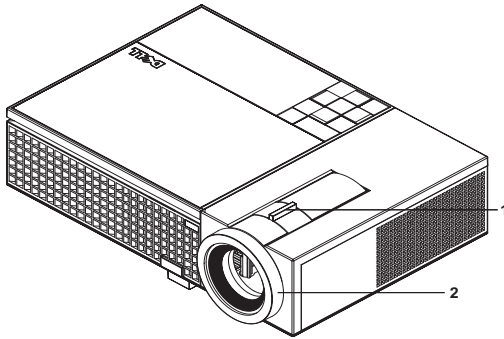

1	Zoom tab
2	Focus ring

# Adjusting Projection Image Size

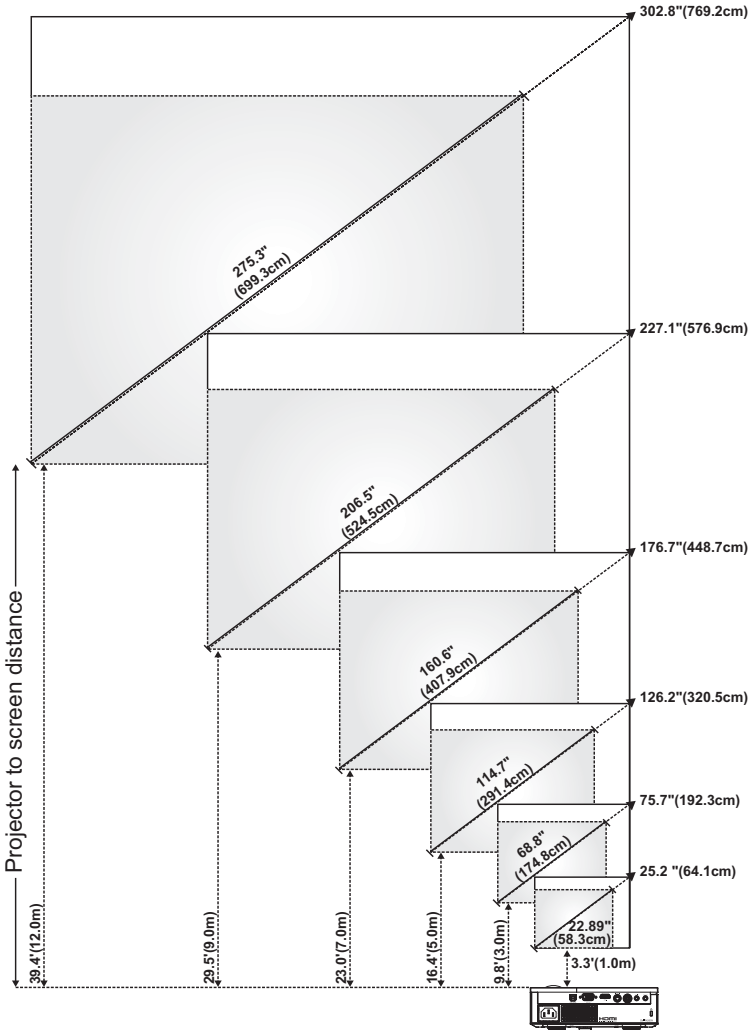

Screen (Diagonal)	Max.	25.2" (64.1cm)	75.7" (192.3cm)	126.2" (320.5cm)	176.7" (448.7cm)	227.1" (576.9cm)	302.8" (769.2cm)
	Min.	22.89" (58.3cm)	68.8" (174.8cm)	114.7" (291.4cm)	160.6" (407.9cm)	206.5" (524.5cm)	275.3" (699.3cm)
Screen Size	Max. (WxH)	20.2"X15.1"	60.6" X45.4"	101.0" X 75.7"	141.3" X106"	181.7" X 136.3"	242.3" X 181.7"
		(51.3cm X 38.5cm)	(153.8cm X 115.4cm)	(256.4cm X 192.3cm)	(359.0cm X 269.2cm)	(461.5cm X 346.2cm)	(615.4cm X 461.5cm)
	Min. (WxH)	18.3" X 13.7"	55.1" X 41.3"	91.8" X 68.8"	128.5" X 96.4"	165.2" X 123.9"	220.3" X 165.2"
		(46.5cm X 34.9cm)	(139.9cm X 104.9cm)	(233.1cm X 174.8cm)	(326.3cm X 244.8cm)	(419.6cm X 314.7cm)	(559.4cm X 419.6cm)
Hd	Max.	2.27" (5.8cm)	6.81" (17.3cm)	11.36" (28.8cm)	15.9" (40.4cm)	20.44" (51.9cm)	27.26" (69.2cm)
	Min.	2.06" (5.2cm)	6.19" (15.7cm)	10.32" (26.2cm)	14.45" (36.7cm)	18.58" (47.2cm)	24.78" (62.9cm)
Distance		3.3' (1.0m)	9.8' (3.0m)	16.4' (5.0m)	23.0' (7.0m)	29.5' (9.0m)	39.4' (12.0m)
* This graph is for user reference only.							

## Using the Control Panel

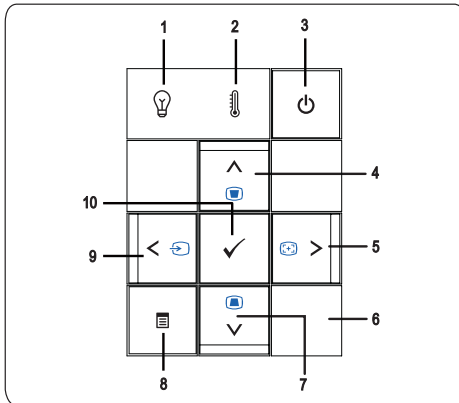

### 1 LAMP warning light



If the LAMP light is solid amber, replace the lamp. If the LAMP light is blinking amber, the lamp driver or color wheel have failed and the projector automatically shuts down. If the problem persists, contact Dell™.

2	TEMP warning light	<ul style="list-style-type: none"> <li>• A solid amber TEMP light indicates that the projector, lamp, or lamp driver are overheated. The display automatically shuts down. Turn the display on again after the projector cools down. If the problem persists, contact Dell™.</li> <li>• A blinking amber TEMP light indicates that a projector fan or color wheel have failed and the projector automatically shuts down. If the problem persists, contact Dell™.</li> </ul>
3	Power	Turn the projector on and off. For more information, see "Turning Your Projector On" on page 15 and "Turning Your Projector Off" on page 15.
4	Up (▲) / Keystone adjustment	<p>Press to select the On Screen Display (OSD) items.</p> <p>Press to adjust image distortion caused by tilting the projector. (+40/-35 degrees)</p>
5	Right (▶) / Auto Adjust	<p>Press to adjust the OSD setting.</p> <p>Press to synchronize the projector to the input source. <b>Auto Adjust</b> does not operate if the on-screen display (OSD) is displayed.</p>
6	IR Receiver	Point the remote control towards the IR receiver and press a button.
7	Down (▼) / Keystone adjustment	<p>Press to select the OSD items.</p> <p>Press to adjust image distortion caused by tilting the projector. (+40/-35 degrees)</p>
8	Menu	Press to activate the OSD. Use the directional keys and the <b>Menu</b> button to navigate through the OSD.
9	Left (◀) / Source	<p>Press to adjust the OSD setting.</p> <p>Press to toggle through Digital RGB, Analog RGB, Composite, Component (YPbPr via VGA), and S-video sources when multiple sources are connected to the projector.</p>
10	Enter	Press to confirm the selection item.

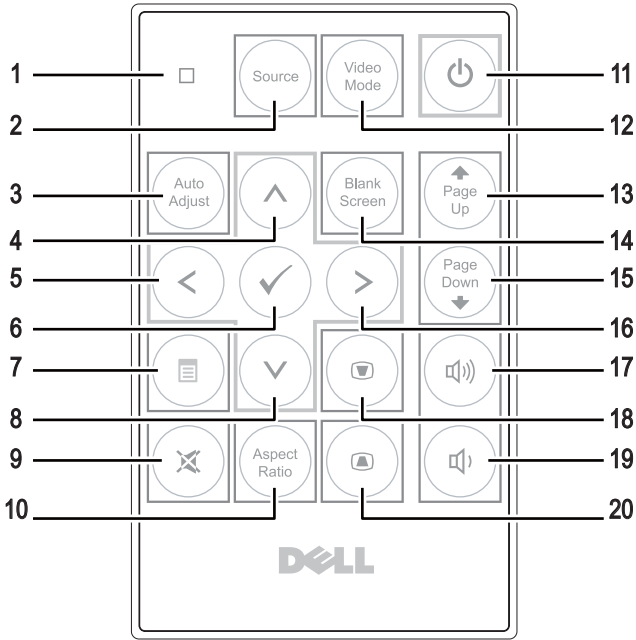
# Using the Remote Control









1	LED light	LED indicator.
2	Source	Press to switch between Digital RGB, Analog RGB, Composite, S-video, Component (YPbPr via VGA).
3	Auto adjust	Press to synchronize the projector to the input source. Auto adjust does not operate if the OSD (On-Screen Display) is displayed.
4	Up button (▲)	Press to select an item on the OSD.
5	Left button (◀)	Press to adjust the OSD setting.
6	Enter	Press to confirm the selection.
7	Menu	Press to activate the OSD.
8	Down button (▼)	Press to select an item on the OSD.
9	Mute	Press to mute or un-mute the projector speaker.

10	Aspect ratio	Press to change the aspect ratio of a displayed image.
11	Power	Turns the projector on and off. For more information, see "Turning Your Projector On" on page 15 and "Turning Your Projector Off" on page 15.
12	Video mode	The Dell 1209S Micro-projector has preset configurations that are optimized for displaying data (PC Graphics) or video (movies, games, etc.). Press the <b>Video Mode</b> button to toggle between <b>PC mode</b> , <b>Movie mode</b> , <b>Game Mode</b> , <b>sRGB</b> , or <b>CUSTOM mode</b> (for user to setup and save preferred settings). Pressing the <b>Video Mode</b> button once will show the current display mode. Pressing the <b>Video Mode</b> button again will switch between display modes.
13	Page up 	Press to move to the previous page.
14	Blank screen	Press to hide/un-hide the image.
15	Page down 	Press to move to the next page.
16	Right button 	Press to adjust the OSD setting.
17	Volume up	Press to increase the volume.
18	Keystone adjustment	Press to adjust image distortion caused by tilting the projector. (+40/-35 degrees)
19	Volume down	Press to decrease the volume.
20	Keystone adjustment	Press to adjust image distortion caused by tilting the projector. (+40/-35 degrees)

## Using the On-Screen Display

The projector has a multi-language On-Screen Display (OSD) that can be displayed with or without an input source present.

To navigate through the tabs in the Main Menu, press the  or  buttons on your projectors control panel or remote control. To select a submenu, press the **Enter** button on your projectors control panel or remote control.

To select an option, press the  or  on your projectors control panel or remote control. The color changes to dark blue. When an item is selected, the color changes to dark blue. Use  or  on the control panel or remote control to

adjust the settings.

To go back to Main Menu, go to Back tab and press the **Enter** button on the control panel or the remote control.

To exit the OSD, go to EXIT tab and press the **Enter** button or press the **Menu** button directly on the control panel or the remote control.

## Main Menu

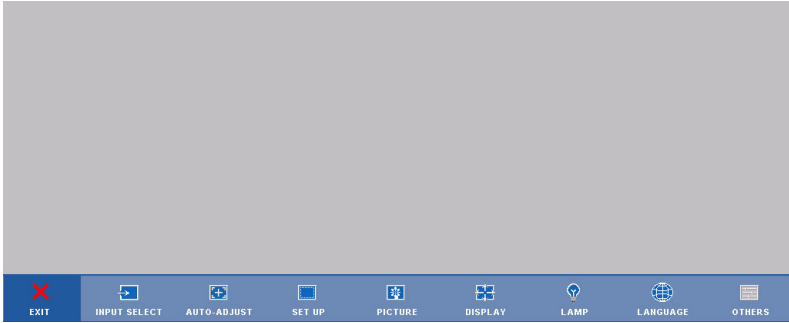

## INPUT SELECT

The Input Select menu allows you to select your projector's input source.

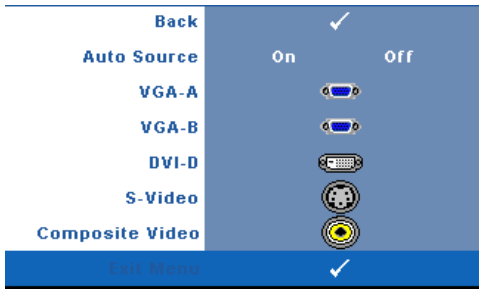

**AUTO SOURCE**—Select **On** (the default) to autodetect the available input signals. If you press the **Source** button when the projector is on, it automatically finds the next available input signal. Select **Off** to lock the current input signal. If you press the **Source** button when the **Auto Source** mode is set to **Off**, you can

manually select the input signal.

**VGA-A**—Press **Enter** to detect VGA-A signal.

**VGA-B**—Press **Enter** to detect VGA-B signal.

**DVI-D**—Press **Enter** to detect DVI-D signal.

**S-VIDEO**—Press **Enter** to detect S-Video signal.

**COMPOSITE VIDEO**—Press **Enter** to detect Composite Video signal.

## AUTO-ADJUST

Auto Adjustment in Progress...

Auto Adjust automatically adjusts the projector's **FREQUENCY** and **TRACKING** in PC mode. While

Auto Adjustment is in progress, the following message appears on the screen, "Auto Adjustment in Progress...".

## SET UP



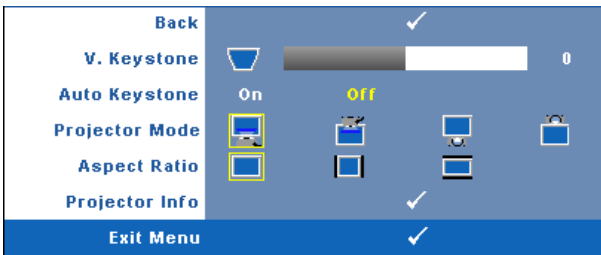

It includes **V. Keystone**, **Auto Keystone**, **Projector Mode**, **Aspect Ratio** and **Projector Info** settings.





**V. KEYSTONE**—Adjusts the image distortion caused by tilting the projector.

**AUTO KEYSTONE**—Auto adjusts the image distortion by tilting the projector.

**PROJECTOR MODE**—Allows you to select the projector mode, depending upon how the projector is mounted.

-  Front Projection-Desktop — This is the default option.
-  Front Projection-Ceiling Mount — The projector turns the image upside down for ceiling-mounted projection.
-  Rear Projection-Desktop — The projector reverses the image so that you can project from behind a translucent screen.
-  Rear Projection-Ceiling Mount — The projector reverses and turns the image upside down. You can project from behind a translucent screen with a ceiling-mounted projection.

**ASPECT RATIO**—Allows you to set the aspect ratio.

-  Original — The input source scales to fit the screen while keeping the aspect ratio of the input source.
-  4:3 — The input source scales to fit the screen.
-  Wide — The input source scales to fit the width of the screen.

Use Wide or 4:3 if you are using one of the following:

- Computer resolution greater than SVGA



– Component cable (720p/1080i/1080p)

**PROJECTOR INFO**—Displays the projector model name, the present input source and projector series number (PPID#).

## PICTURE (in PC Mode)

Using the **Picture** menu, you can adjust the display settings of your projectors. The Picture menu, provides the following options:

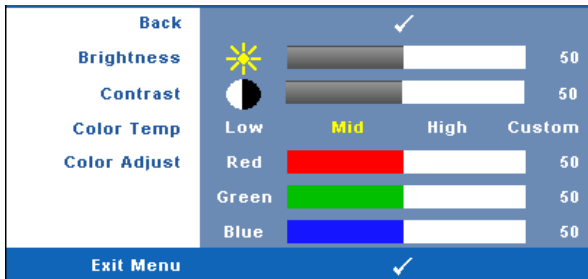

**BRIGHTNESS**—Use ⏪ and ⏩ to adjust the brightness of the image.

**CONTRAST**—Use ⏪ and ⏩ to adjust the display contrast.

**COLOR TEMP**—Allows you to adjust the color temperature. The screen appears cooler at higher color temperatures and warmer at lower color temperatures. When you adjust the values in the **Color Adjust** menu, the Custom mode is activated. The values are saved in the Custom mode.

**COLOR ADJUST**—Allows you to manually adjust the colours red, green, and blue.

## PICTURE (in Video Mode)

Using the **Picture** menu, you can adjust the display settings of your projectors. The Picture menu, provides the following options:

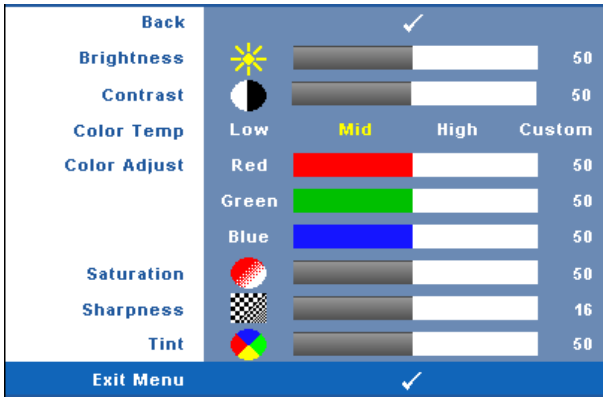

**BRIGHTNESS**—Use ◀ and ▶ to adjust the brightness of the image.

**CONTRAST**—Use ◀ and ▶ to adjust the display contrast.

**COLOR TEMP**—Allows you to adjust the color temperature. The screen appears cooler at higher color temperatures and warmer at lower color temperatures. When you adjust the values in the **Color Adjust** menu, the Custom mode is activated. The values are saved in the Custom mode.

**COLOR ADJUST**—Allows you to manually adjust the colours red, green, and blue.

**SATURATION**—Allows you to adjust the video source from black and white to fully saturated color. Press ◀ to decrease the amount of color in the image and ▶ to increase the amount of color in the image.

**SHARPNESS**—Press ◀ to decrease the sharpness and ▶ to increase the sharpness.

**TINT**—Press ◀ to increase the amount of green in the image and ▶ to increase the amount of red in the image (Selectable for NTSC only).

## DISPLAY (in PC Mode)

Using the **Display** menu, you can adjust the display settings of your projectors. The **Picture** menu, provides the following options:

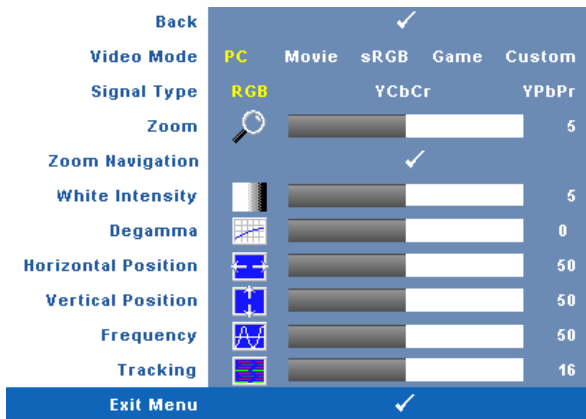

**VIDEO MODE**—Allows you to optimize the projectors display mode:

PC, Movie, sRGB (provides more accurate color representation), Game, and Custom (set your preferred settings). If you adjust the settings for **White Intensity** or **Degamma**, the projector automatically switches to **Custom**.



**NOTE:** If you adjust the settings for **White Intensity** or **Degamma**, the projector automatically switches to **Custom**.

**SIGNAL TYPE**—Allows you to manually select signal type RGB, YCbCr, or YPbPr.

**ZOOM**—Press  $\odot$  to digitally magnify an image up to 4 times on the projection screen and press  $\ominus$  to reduce the zoomed image.

**ZOOM NAVIGATION**—Press  $\odot$   $\ominus$   $\uparrow$   $\downarrow$  to navigate projection screen.

**WHITE INTENSITY**—Set 0 to maximize the color reproduction and 10 to maximize the brightness.

**DEGAMMA**—Allows you to adjust among the 4 preset values (1, 2, 3, 4) to change the color performance of the display.

**HORIZONTAL POSITION**—Press  $\ominus$  to move the image to the left and  $\odot$  to move the image to the right.

**VERTICAL POSITION**—Press  $\ominus$  to move the image down and  $\odot$  to move the image up.

**FREQUENCY**—Allows you to change the display data clock frequency to match the frequency of your computer graphics card. If you see a vertical flickering wave, use **Frequency control** to minimize the bars. This is a coarse adjustment.

**TRACKING**—Synchronize the phase of the display signal with the graphic card. If you experience an unstable or flickering image, use **Tracking** to correct it. This is a fine adjustment.

## DISPLAY (in Video Mode)

Using the **Display** menu, you can adjust the display settings of your projectors. The **Picture** menu, provides the following options:

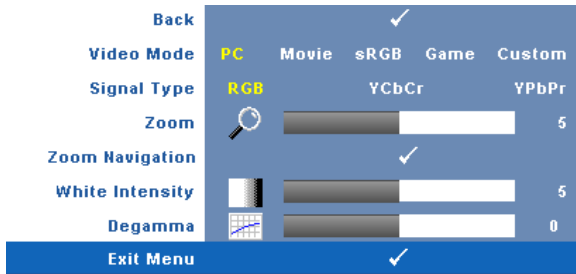

**VIDEO MODE**—Allows you to optimize the projectors display mode:

PC, Movie, sRGB (provides more accurate color representation), Game, and Custom (set your preferred settings). If you adjust the settings for **White Intensity** or **Degamma**, the projector automatically switches to **Custom**.



**NOTE:** If you adjust the settings for **White Intensity** or **Degamma**, the projector automatically switches to **Custom**.

**SIGNAL TYPE**—Manually select signal type RGB, YCbCr, or YPbPr.

**ZOOM**—Press  $\odot$  to digitally magnify an image up to 4 times on the projection screen and press  $\ominus$  to reduce the zoomed image.

**ZOOM NAVIGATION**—Press  $\odot$   $\ominus$   $\wedge$   $\vee$  to navigate projection screen.

**WHITE INTENSITY**—Set 0 to maximize the color reproduction and 10 to maximize the brightness.

**DEGAMMA**—Adjust among the 4 preset values (1, 2, 3, 4) to change the color performance of the display.

## LAMP

Using the **Lamp** menu, you can adjust the display settings of your projectors. The Picture menu, provides the following options:

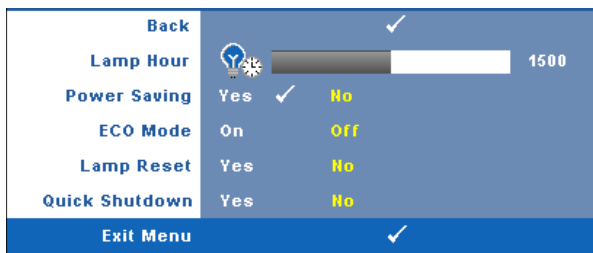

**LAMP HOUR**—Displays the operating hours since the last lamp timer reset.

**POWER SAVING**—Select **Yes** to set the Power Saving delay period. The delay period is the time you want the projector to wait without an input signal. By default, the delay period is set to 120 minutes. However, you can set this to 5, 15, 30, 45, 60, or 120 minutes.

If an input signal is not detected during the delay period, the projector turns off the lamp and goes into power saving mode. If an input signal is detected within the delay period, the projector automatically turns on. If an input signal is not detected within two hours, the projector switches from Power Saving mode to Power Off mode. To turn on the projector press the Power button.

**ECO MODE**—Select **On** to use the projector at a lower power level (165 Watts), which may provide longer lamp life, quieter operation, and dimmer luminance output on the screen. Select **Off** to operate at normal power level (200 Watts).

**LAMP RESET**—After you install a new lamp, select **Yes** to reset the lamp timer.

**QUICK SHUTDOWN**—Select **Yes** to turn off the projector with a single press of the **Power** button. This function allows the projector to quick power off with an accelerated fan speed. Slightly higher acoustic noise is expected during quick power off.

## LANGUAGE

The Language menu allows you to set the language for the OSD.



## OTHERS

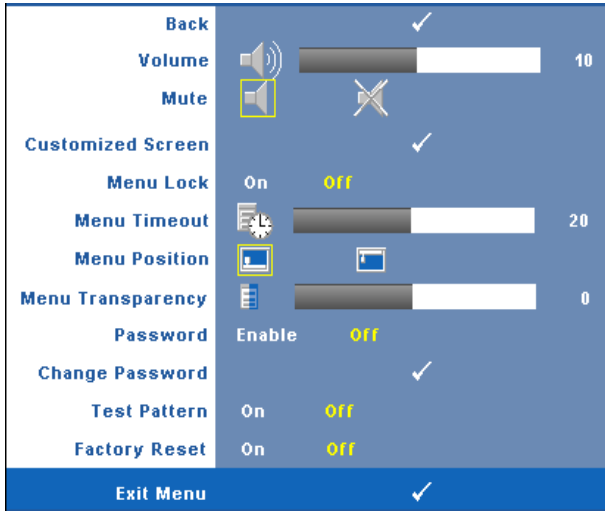

**VOLUME**—Press ◀ and ▶ to decrease/increase the volume.

**MUTE**—Allows you to mute the sound.

**CUSTOMIZED SCREEN**—Press Enter to pop up a Customized Screen menu. Input in a source at native resolution then press Enter and select "Yes". The projector will capture the screen image as a "My Customized logo". This screen replaces all the original screens with the Dell logo. User can recover the default screen by selecting **Dell Logo** on the pop-up screen.

**MENU LOCK**—Select **On** to enable Menu Lock and hide the OSD menu. Select **OFF** to disable the Menu Lock and display the OSD menu.

 **NOTE:** If the OSD disappears while you disable Menu Lock, press the **Menu** button on the projectors control panel for 15 seconds, then disable the function.

**MENU TIMEOUT**—Allows you to adjust the time for an **OSD Timeout**. By default, the OSD disappears after 30 seconds of non-activity.

**MENU POSITION**—Allows you to select the position of the OSD menu on the screen.

**MENU TRANSPARENCY**—Select to change the transparency level of the OSD background.

**PASSWORD**—When Password Protect is enabled, a Password Protect screen requesting you to enter a password will be displayed when the power plug is inserted into the electrical outlet and the power for the projector is first turned on. By default, this function is disabled. You can enable this feature using the Password menu. This password security feature will be activated the next time you turn on the projector. If you enable this feature, you will be asked to enter the projector's password after you turn on the projector:

- 1 1st time password input request:
  - a Go to **Others** menu, press **Enter** and then select **Password** to Enable the password setting.

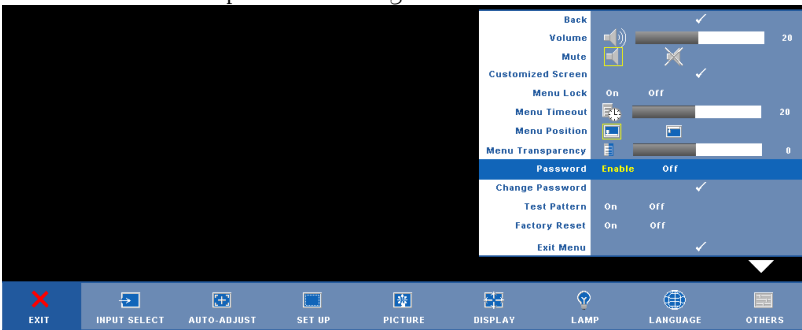

- b Enable the Password function will pop up a character screen, key in a 4-digit number from the screen and press the **Enter** button.

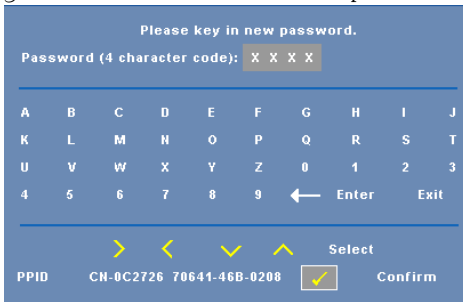

- c To confirm, enter the password again.
      - d If the password verification is successful, you may resume with accessing the projector's functions and its utilities.



- If you have entered incorrect password, you will be given another 2 chances. After the three invalid attempts, the projector will automatically turn off.

 **NOTE:** If you forget your password, contact DELL™ or qualified service personnel.

- To cancel the password function, select **Off** and enter the password to disable the function.

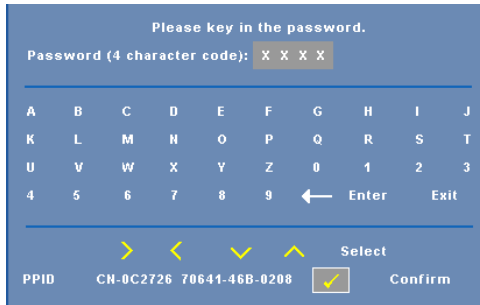

**CHANGE PASSWORD**—Key in the original password, then enter the new password and confirm the new password again.

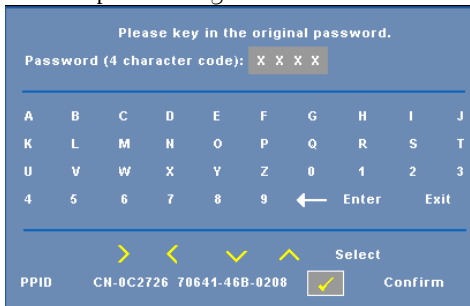



**TEST PATTERN**—Select **On** to activate the built-in **Test Pattern** for self-testing on focus and resolution. Select **Off** to disable the function.

**FACTORY RESET**—Select **On** to reset the projector to its factory default settings. Reset items include both computer sources and video source settings.





# Troubleshooting Your Projector

If you experience problems with your projector, see the following troubleshooting tips. If the problem persists, contact Dell™. See [Contacting Dell™](#) on page 44

---

<b>Problem</b>	<b>Possible Solution</b>
No image appears on the screen	<ul style="list-style-type: none"><li>• Ensure that the lens cap is removed and the projector is turned on.</li><li>• Ensure the external graphics port is enabled. If you are using a Dell™ portable computer, press   (Fn+F8). For other computers, see your respective documentation.</li><li>• Ensure that all the cables are securely connected. See on page 7.</li><li>• Ensure that the pins of the connectors are not bent or broken.</li><li>• Ensure that the lamp is securely installed (see on page 38).</li><li>• Use <b>Test Pattern</b> in the <b>Others</b> menu. Ensure that the colors of the test pattern are correct.</li></ul>

---

<b>Problem (continued)</b>	<b>Possible Solution (continued)</b>
Partial, scrolling, or incorrectly displayed image	<ol style="list-style-type: none"> <li><b>1</b> Press the <b>Auto Adjust</b> button on the remote control or the control panel.</li> <li><b>2</b> If you are using a Dell™ portable computer, set the resolution of the computer to XGA (1024 x 768): <ol style="list-style-type: none"> <li><b>a</b> Right-click the unused portion of your Windows desktop, click <b>Properties</b> and then select <b>Settings</b> tab.</li> <li><b>b</b> Verify the setting is 1024 x 768 pixels for the external monitor port.</li> <li><b>c</b> Press   (Fn+F8).</li> </ol> </li> </ol> <p>If you experience difficulty in changing resolutions or your monitor freezes, restart all the equipment and the projector.</p> <p>If you are not using a Dell™ portable computer, see your documentation.</p>
The screen does not display your presentation	If you are using a portable computer, press   (Fn+F8).
Image is unstable or flickering	Adjust the tracking in the OSD <b>Display</b> sub-menu (in PC Mode only).
Image has vertical flickering bar	Adjust the frequency in the OSD <b>Display</b> sub-menu (in PC Mode only).
Image color is incorrect	<ul style="list-style-type: none"> <li>• If the display receives the wrong signal output from the graphics card, please set the signal type to <b>RGB</b> in the OSD <b>Display</b> tab.</li> <li>• Use <b>Test Pattern</b> in the <b>Others</b> menu. Ensure that the colors of the test pattern are correct.</li> </ul>
Image is out of focus	<ol style="list-style-type: none"> <li><b>1</b> Adjust the focus ring on the projector lens.</li> <li><b>2</b> Ensure that the projection screen is within the required distance from the projector (3.3 ft [1.0 m] to 39.4 ft [12 m]).</li> </ol>

<b>Problem (continued)</b>	<b>Possible Solution (continued)</b>
The image is stretched when displaying a 16:9 DVD	<p>The projector automatically detects the input signal format. It will maintain the aspect ratio of the projected image according to input signal format with an Original setting.</p> <p>If the image is still stretched, adjust the aspect ratio in the <b>Set Up</b> menu in the OSD.</p>
Image is reversed	Select <b>Set Up</b> from the OSD and adjust the projector mode.
Lamp is burned out or makes a popping sound	When the lamp reaches its end of life, it may burn out and may make a loud popping sound. If this occurs, the projector does not turn back on. To replace the lamp, see on page 38.
<b>LAMP</b> light is solid amber	If the <b>LAMP</b> light is solid amber, replace the lamp.
<b>LAMP</b> light is blinking amber	<p>If the <b>LAMP</b> light and the <b>Power</b> light are blinking amber, the lamp driver has failed and the projector will automatically shut down.</p> <p>If the <b>LAMP</b> light is blinking amber and <b>Power</b> light is solid blue, the color wheel has failed and the projector will automatically shut down.</p> <p>Unplug the power cord after 3minutes then turn the display on again. If this problem persists, contact Dell™.</p>
<b>TEMP</b> light is solid amber	The projector has overheated. The display automatically shuts down. Turn the display on again after the projector cools down. If the problem persists, contact Dell™.
<b>TEMP</b> light is blinking amber	A projector fan has failed and the projector will automatically shut down. If the problem persists, contact Dell™.
The OSD does not appear on the screen	Try to press the Menu button on the panel for 15 seconds to unlock the OSD. Check the <b>Menu Lock</b> on page 31.

---

**Problem (continued)**

The remote control is not operating smoothly or works only within a limited range

**Possible Solution (continued)**

The battery may be low. Check if the LED indicator from the remote is too dim. If so, replace with a new CR2032 battery.

---

# Changing the Lamp

**⚠ CAUTION:** Before you begin any of the procedures in this section, follow the Safety Instructions as described on page 6.

Replace the lamp when the message "Lamp is approaching the end of its useful life in full power operation. Replacement suggested! [www.dell.com/lamps](http://www.dell.com/lamps)" appears on the screen. If this problem persists after replacing the lamp, contact Dell™. For more information, see Contacting Dell™ on page 44.

**⚠ CAUTION:** The lamp becomes very hot when in use. Do not attempt to replace the lamp until the projector has been allowed to cool down for at least 30 minutes.

**⚠ CAUTION:** Do not touch the bulb or the lamp glass at any time. Projector lamps are very fragile and may shatter if touched. The shattered glass pieces are sharp and can cause injury.

**⚠ CAUTION:** If the lamp shatters, remove all broken pieces from the projector and dispose or recycle according to state, local, or federal law. For more information see - [www.dell.com/hg](http://www.dell.com/hg).

- 1 Turn off the projector and disconnect the power cord.
- 2 Let the projector cool for at least 30 minutes.
- 3 Loosen the two screws that secure the lamp cover, and remove the cover.
- 4 Loosen the two screws that secure the lamp.
- 5 Pull the lamp up by its metal handle.

**✎ NOTE:** Dell™ may require lamps replaced under warranty to be returned to Dell™. Otherwise, contact your local waste disposal agency for the address of the nearest deposit site.

- 6 Replace with the new lamp.
- 7 Tighten the two screws that secure the lamp.
- 8 Replace the lamp cover and tighten the two screws.
- 9 Reset the lamp usage time by selecting "Yes" for Lamp Reset in the OSD Lamp tab. (See Lamp menu on page 29)

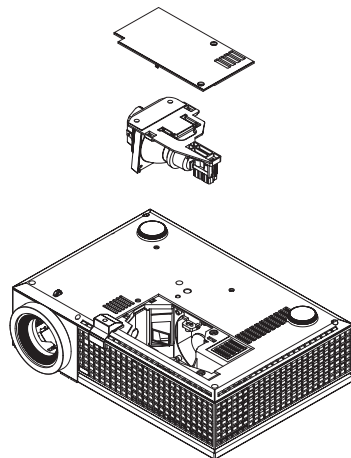



**CAUTION: Lamp Disposal (for the US only)**



**LAMP(S) INSIDE THIS PRODUCT CONTAIN MERCURY AND MUST BE RECYCLED OR DISPOSED OF ACCORDING TO LOCAL, STATE OR FEDERAL LAWS. FOR MORE INFORMATION, GO TO [WWW.DELL.COM/HG](http://WWW.DELL.COM/HG) OR CONTACT THE ELECTRONIC INDUSTRIES ALLIANCE AT [WWW.EIAE.ORG](http://WWW.EIAE.ORG). FOR LAMP SPECIFIC DISPOSAL INFORMATION CHECK [WWW.LAMPRECYCLE.ORG](http://WWW.LAMPRECYCLE.ORG).**

## Specifications

Light Valve	0.55" SVGA DMD Type X, DarkChip1™
Brightness	2500 ANSI Lumens (Max.)
Contrast Ratio	1800:1 Typical (Full On/Full Off)
Uniformity	85% Typical (Japan Standard - JBMA)
Number of Pixels	800 x 600 (SVGA)
Displayable Color	16.7M colors
Color Wheel Speed	2X
Projection Lens	F-Stop: F/2.41~2.55 Focal length, f=21.8~24 mm 1.1X manual Zoom Lens
Projection Screen Size	22.89-302.8 inches (diagonal)
Projection Distance	3.3~39.4 ft (1.0 m~12 m)
Video Compatibility	Composite Video / S-Video: NTSC (J, M, 4.43), PAL (B, D, G, H, I, M, N, Nc, 60), SECAM (B, D, G, K, K1, L)  Component Video via VGA & DVI-D: 1080i/p, 720p, 576i/p, 480i/p
Power Supply	Universal AC90-264 50/60 Hz with PFC input
Power Consumption	256 watts in full mode, 216 watts in eco mode
Audio	1 speaker, 8 watt RMS
Noise Level	34 dB(A) Full-on mode, 31 dB(A) Eco mode
Weight	4.95 lbs (2.25 kg)
Dimensions (W x H x D)	External 11.68 x 7.96 x 3.17 ± 0.04 inches (296.5 x 202 x 80.5 ± 1 mm)



Environmental	<p>Operating temperature: 5°C - 35°C (41°F- 95°F)  Humidity: 80% maximum</p> <p>Storage temperature: 0°C to 60°C  (32°F to 140°F)  Humidity: 90% maximum</p>
Regulatory	FCC, CE, VCCI, UL, cUL, Nemko-GS, ICES-003, MIC, C-Tick, GOST, CCC, PSB, NOM, IRAM, SABS, CECP, SASO, PSE, eK
I/O Connectors	<p>Power: AC power input socket</p> <p>Computer input: two D-sub for analog/component, HDTV input signals</p> <p>Computer output: one 15-pin D-sub</p> <p>Video input: one composite video RCA and one S-video</p> <p>Audio input: one phone jack (diameter 3.5 mm)</p> <p>Audio output: one phone jack (diameter 3.5 mm)</p> <p>USB port: One USB slave for remote support</p> <p>One mini-DIN RS232 for wired remote control from PC</p> <p>DVI-D input: one DVI-D connector for DVI-D signal (HDCP compliant).</p>
Lamp	165~200-watt user-replaceable 3000-hour lamp (up to 4000 hours in eco mode)



**NOTE:** The actual operating life span of a projector lamp will vary according to operating conditions and usage patterns. Usage of a projector in stressful conditions which may include dusty environments, under high temperatures and abrupt powering-off may result in a lamp's shortened operating life span or possibly lamp failure. The lamp life specified for Dell's projectors refers to the typical time under non-stressful operating conditions for more than 50% of a sampling population to reduce to approximately 50% of the lamp's rated brightness level. It is not the measure of time a lamp will cease light output.

## RS232 Pin Assignment

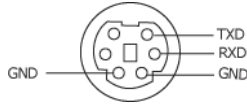

### RS232 Protocol

- Communication Settings

Connection settings	Value
Baud Rate:	19200
Data Bits:	8
Parity	None
Stop Bits	1

- Command types

To pop up the OSD menu and adjust the settings.

- Control command Syntax (From PC to Projector)

[H][AC][SoP][CRC][ID][SoM][COMMAND]

- Example: Power ON Command (Send low byte firstly)

--> 0xBE, 0xEF, 0x10, 0x05, 0x00, 0xC6, 0xFF, 0x11, 0x11, 0x01, 0x00, 0x01

- Control Commands List

To view the latest RS232 code, go to the Dell Support site at: [support.dell.com](http://support.dell.com).

## Compatibility Modes (Analog/Digital)

Resolution	V. Frequency (Hz)	H. Frequency (KHz)
640X480	59.9	31.5
640X480	75	37.5
640X480	85	43.3
720X400	70.1	31.5
720X400	85	37.9
800X600	60.3	37.9
800X600	75	46.9
800X600	85.1	53.7
848X480	60	31
1024X768	60	48.4
1024X768	75	60
1024X768	85	68.7
1280X720	59.9	44.8
1280X768	59.9	47.8
1280X800	59.8	49.7
1280X1024	60	64
1280X1024	75	80
1280X1024	85	91.1
1360X768	60	47.7
1400X1050	60	65.3
1440X900	59.9	55.9
1680X1050	60	65.3
1600X1200	60	75

# Contacting Dell™

For customers in the United States, call 800-WWW-DELL (800-999-3355).



**NOTE:** If you do not have an active Internet connection, you can find contact information on your purchase invoice, packing slip, bill, or Dell product catalog.

Dell provides several online and telephone-based support and service options. Availability varies by country and product, and some services may not be available in your area. To contact Dell for sales, technical support, or customer service issues:

- 1 Visit [support.dell.com](http://support.dell.com).
- 2 Verify your country or region in the **Choose A Country/Region** drop-down menu at the bottom of the page.
- 3 Click **Contact Us** on the left side of the page.
- 4 Select the appropriate service or support link based on your need.
- 5 Choose the method of contacting Dell that is convenient for you.

# Appendix: Glossary

**ANSI LUMENS**—A standard for measuring the brightness. It is calculated by dividing a square meter image into nine equal rectangles, measuring the lux (or brightness) reading at the center of each rectangle, and averaging these nine points.

**ASPECT RATIO**—The most popular aspect ratio is 4:3 (4 by 3). Early television and computer video formats are in a 4:3 aspect ratio, which means that the width of the image is  $\frac{4}{3}$  times the height.

**Brightness**—The amount of light emitting from a display or projection display or projection device. The brightness of projector is measured by ANSI lumens.

**Color Temperature**—The color appearance of white light. Low color temperature implies warmer (more yellow/red) light while high color temperature implies a colder (more blue) light. The standard unit for color temperature is Kelvin (K).

**Component Video**—A method of delivering quality video in a format that consists of the luminance signal and two separate chrominance signals and are defined as Y'Pb'Pr' for analog component and Y'Cb'Cr' for digital component. Component video is available on DVD players.

**Composite Video**—A video signal that combines the luma (brightness), chroma (color), burst (color reference), and sync (horizontal and vertical synchronizing signals) into a signal waveform carried on a single wire pair. There are three kind of formats, namely, NTSC, PAL and SECAM.

**Compressed Resolution**—If the input images are of higher resolution than the native resolution of the projector, the resulting image will be scaled to fit the native resolution of the projector. The nature of compression in a digital device means that some image content is lost.

**Contrast Ratio**—Range of light and dark values in a picture, or the ratio between their maximum and minimum values. There are two methods used by the projection industry to measure the ratio:

1 *Full On/Off*—measures the ratio of the light output of an all white image (full on) and the light output of an all black (full off) image.

2 *ANSI*—measures a pattern of 16 alternating black and white rectangles. The average light output from the white rectangles is divided by the average light output of the black rectangles to determine the ANSI contrast ratio.

*Full On/Off* contrast is always a larger number than ANSI contrast for the same projector.

**dB**— decibel—A unit used to express relative difference in power or intensity, usually between two acoustic or electric signals, equal to ten times the common logarithm of the ratio of the two levels.

**Diagonal Screen**— A method of measuring the size of a screen or a projected image. It measures from one corner to the opposite corner. A 9FT high, 12FT wide, screen has a diagonal of 15FT. This document assumes that the diagonal dimensions are for the traditional 4:3 ratio of a computer image as per the example above.

**DLP**<sup>®</sup>— Digital Light Processing<sup>™</sup>—Reflective display technology developed by Texas Instruments, using small manipulated mirrors. Light passes through a color filter is sent to the DLP mirrors which arrange the RGB colors into a picture projected onto screen, also known as DMD.

**DMD**— digital Micro- Mirror Device— Each DMD consists of thousands of tilting, microscopic aluminum alloy mirrors mounted on a hidden yoke.

**DVI-D**— Digital Visual Interface-Digital connector.

**Focal Length**— The distance from the surface of a lens to its focal point.

**Frequency**— It is the rate of repetition in cycles per seconds of electrical signals. Measured in Hz (Hertz).

**Hz (Hertz)**— Unit of frequency.

**Keystone Correction**— Device that will correct an image of the distortion (usually a wide-top narrow-bottom effect) of a projected image caused by improper projector to screen angle.

**Maximum Distance**— The distance from a screen the projector can be to cast an image that is usable (bright enough) in a fully darkened room.

**Maximum Image Size**— The largest image a projector can throw in a darkened room. This is usually limited by focal range of the optics.

**Minimum Distance**— The closest position that a projector can focus an image onto a screen.

**NTSC**— National Television Standards Committee. North American standard for video and broadcasting, with a video format of 525 lines at 30 frames per second.

**PAL**— Phase Alternating Line. A European broadcast standard for video and broadcasting, with a video format of 625 lines at 25 frames per second.

**Reverse Image**— Feature that allows you to flip the image horizontally. When used in a normal forward projection environment text, graphics, etc, are backwards. Reverse image is used for rear projection.

**RGB**— Red, Green, Blue— typically used to describe a monitor that requires separate signals for each of the three colors.

**S-Video**—A video transmission standard that uses a 4-pin mini-DIN connector to send video information on two signal wires called luminance (brightness, Y) and chrominance (color, C). S-Video is also referred to as Y/C.

**SECAM**— A French and international broadcast standard for video and broadcasting, closely related to PAL but with a different method of sending color information.

**SVGA**— Super Video Graphics Array— 800 x 600 pixels count.

**SXGA**— Super Extended Graphics Array,—1280 x 1024 pixels count.

**UXGA**— Ultra Extended Graphics Array—1600 x 1200 pixels count.

**VGA**— Video Graphics Array—640 x 480 pixels count.

**XGA**— Extended Video Graphics Array— 1024 x 768 pixels count.

**Zoom Lens**— Lens with a variable focal length that allows operator to move the view in or out making the image smaller or larger.

**Zoom Lens Ratio**— Is the ratio between the smallest and largest image a lens can projector from a fixed distance. For example, a 1.4:1 zoom lens ratio means that a 10 foot image without zoom would be a 14 foot image with full zoom.

# Index

## A

- Adjusting the Projected Image 16
  - Adjusting the Projector Height 16
    - lower the projector
      - Elevator button 16
      - Elevator foot 16
      - Tilt adjustment wheel 16
- Adjusting the Projector Zoom and Focus 17
  - Focus ring 17
  - Zoom tab 17

## C

- Changing the Lamp 38
- Connecting the Projector
  - Composite video cable 12
  - Connecting a Computer with a RS232 cable 10
  - Connecting with a Component Cable 13
  - Connecting with a Composite Cable 12
  - Connecting with an HDMI Cable 14
  - Connecting with an S-video Cable 11
  - DVI-D adapter 14
  - HDMI cable 14
  - Power cord 8, 9, 10, 11, 12, 13,

14

- RS232 cable 10
- S-video cable 11
- To Computer 8, 9
- USB to USB cable 8, 9
- VGA to VGA cable 8, 9
- VGA to YPbPr cable 13

## Connection Ports

- Audio input connector 7
- Audio output connector 7
- Composite video connector 7
- DVI-D input connector 7
- Power cord connector 7
- RS232 connector 7
- Security cable slot 7
- S-video connector 7
- USB remote connector 7
- VGA-A input (D-sub) connector 7
- VGA-A output (monitor loop-through) 7
- VGA-B input (D-sub) connector 7

Contact Dell 5, 19, 20, 36, 38

Control Panel 19

## D

- Dell
  - contacting 44



## M

- Main Unit 6
  - Control panel 6
  - Elevator button 6
  - Focus ring 6
  - IR receiver 6
  - Lens 6
  - Zoom tab 6

## O

- On-Screen Display 22
  - Auto-Adjust 24
  - Display (in PC Mode) 27
  - Display (in Video Mode) 28
  - Input Select 23
  - Lamp 29
  - Language 30
  - Main Menu 23
  - Others 31
  - Picture (in PC Mode) 25
  - Picture (in Video Mode) 26
  - Set Up 24

## P

- phone numbers 44
- Powering On/Off the Projector
  - Powering Off the Projector 15
  - Powering On the Projector 15

## R

- Remote Control 21
  - IR receiver 20

## S

- Specifications
  - Audio 40
  - Brightness 40
  - Color Wheel Speed 40
  - Contrast Ratio 40
  - Dimensions 41
  - Displayable Color 40
  - Environmental 41
  - I/O Connectors 41
  - Lamp 40
  - Light Valve 40
  - Noise Level 41
  - Number of Pixels 40
  - Power Consumption 40
  - Power Supply 40
  - Projection Distance 40
  - Projection Lens 40
  - Projection Screen Size 40
  - Regulatory 41
  - RS232 Protocol 42
  - Uniformity 40
  - Video Compatibility 40
  - Weight 41

- support
  - contacting Dell 44

## T

- telephone numbers 44
- Troubleshooting 34
  - Contact Dell 34